

# Sapphire-design thermocouple

## For high-temperature measurements with safety chamber

### Model TC84

WIKA data sheet TE 65.84



for further approvals  
see page 2

#### Applications

- Gasification reactors
- GtL reactors (Gas-to-Liquids)
- Sulphur recovery plants

#### Special features

- 3 times longer service life in comparison to purely ceramic protection tubes due to the monocrystalline structure of the sapphire sensor protection tube
- High process safety with processes up to 1,700 °C [3,092 °F] and 65 bar [943 psi]
- Reduction of unplanned downtime
- Increased safety through double sealing system against escape of toxic media
- Cost savings through the elimination of a purge system and the reparability of the sensor



**Sapphire sensor with ceramic outer protection tube, model TC84**







#### Description

This high-temperature thermocouple with a gas-tight sapphire protection tube has been specifically developed for use in gasification reactors. Through the monocrystalline structure, the sapphire protects the precious metal of the thermocouple from poisonous toxic media in the aggressive atmosphere of the gasification reactor.

This solution has been used successfully in different reactors worldwide since 1997 under the designation model T-FZV. Hermetically sealed, pressure-tight junctions between the sapphire and metal protection tube, and also a multifold sealing system in the connection housing prevents toxic gases from being able to escape the reactor.

The high temperatures and pressures in the gasification process place very high demands on protection tubes and thermocouples. These process conditions often lead to shutdowns and interruptions in operation. Utilizing the patented sapphire design can significantly improve life expectancy and reduce downtime.

## Approvals

Logo	Description	Country
 	<b>EU declaration of conformity</b> <ul style="list-style-type: none"> <li>■ RoHS directive</li> <li>■ ATEX directive (option)            Hazardous areas            - Ex n Zone 2 gas II 3G Ex nA IIC T1 ... T6 Gc X            - Ex e Zone 2 gas II 3G Ex ec IIC T1 ... T6 Gc X</li> </ul>	European Union
	<b>IECEx (option)</b> Hazardous areas - Ex n Zone 2 gas Ex nA IIC T1 ... T6 Gc - Ex e Zone 2 gas Ex ec IIC T1 ... T6 Gc	International
	<b>EAC (option)</b> Hazardous areas - Ex n Zone 2 gas Ex nA IIC T6 ... T1 Gc X	Eurasian Economic Community
	<b>GOST (option)</b> Metrology, measurement technology	Russia
	<b>BelGIM (option)</b> Metrology, measurement technology	Belarus
	<b>UkrSEPRO (option)</b> Metrology, measurement technology	Ukraine

### Permissible ambient temperature range

-40 ... +80 °C [-40 ... +392 °F] for temperature class T1 ... T6 or -40 ... +200 °C [-40 ... +392 °F] for temperature class T1 ... T3

Approvals and certificates, see website

## Sensor

### Sensor types

Model	Recommended max. operating temperature
	IEC 60584-1
<b>S</b>	1,600 °C [2,912 °F]
<b>R</b>	1,600 °C [2,912 °F]
<b>B</b>	1,700 °C [3,092 °F]

Thermocouple	Class
<b>Model</b>	IEC 60584-1:2013
<b>S</b>	1 and 2
<b>R</b>	1 and 2
<b>B</b>	2

### Tolerance value

For the tolerance value of thermocouples, a cold junction temperature of 0 °C has been taken as the basis.

For detailed specifications for thermocouples, see Technical information IN 00.23 at [www.wika.com](http://www.wika.com).

The actual operating temperature of the thermometer is limited both by the maximum permissible working temperature of the thermocouple, as well as by the maximum permissible working temperature of the protection tube material.

The long-term stability of precious-metal thermocouples rises with increasing thermocouple wire diameter. The type S, R and B sensors are only available with a diameter of 0.5 mm [0.02"].

## Versions

Both variants feature a connection housing with a solid-machined safety chamber. Two special pressure-tight ceramic feed-throughs serve as the electrical connection to the thermocouple.

- Ceramic outer protection tube, measuring insert with sapphire protection tube in processes with high hydrogen content
- Ceramic outer protection tube, measuring insert with ceramic protection tube in processes with low or no hydrogen content

Further options and variants on request

## Process connection <sup>1)</sup>

### Nominal size

- ASME: 1 ½" ... 4"
- EN 1092-1: DN40 ... DN100

### Pressure ratings

- ASME: 300 ... 1,500 lbs
- EN 1092-1: PN40 ... PN100

### Sealing face

- ASME: RF, RTJ, LT, ST
- EN 1092-1: Form B1, B2, E, C

Flanges in accordance with other standards on request

1) The connection housing is manufactured from forged bar stock and the dimensions correspond to ASME

## Materials

### Connection housing and flange

- 1.4541
- 1.5415
- 1.7335
- 1.7380
- F11
- F22
- SS321

Other materials are available on request

### Outer protection tube

- Ceramic C799: Ø 15 x 2.5 mm
- Ceramic C610: Ø 15 x 2 mm

### Protection tube material for measuring insert

Sapphire or C799 ceramic with Ø 8 mm

## Tests

The following pressure tests are carried out on every TC84:

- Measuring insert at 100 bar [1,450 psi]
- Ceramic feed-through of the secondary sealing at 100 bar [1,450 psi]
- Entire measuring instrument at 1.5 times flange pressure rating

Option:

- Calibration at 3 test points (900 °C [1,652 °F], 1,000 °C [1,832 °F] and 1,100 °C [2,012 °F])
- Calibration at 3 test points (1,000 °C [1,832 °F], 1,200 °C [2,192 °F] and 1,400 °C [2,552 °F])

Further tests are available on request.

## Protection mechanisms

The primary sealing serves as protection against escape from the process at high pressure and high temperature.

The secondary sealing is the safeguard in the event of a malfunction in the primary seal due to any unforeseeable disturbance to the primary seal.

### Double-protected sensor tip

- Ceramic outer protection tube for protection against harsh process conditions
- Sapphire measuring insert protection tube for internal protection against contamination of the thermocouples through diffusion

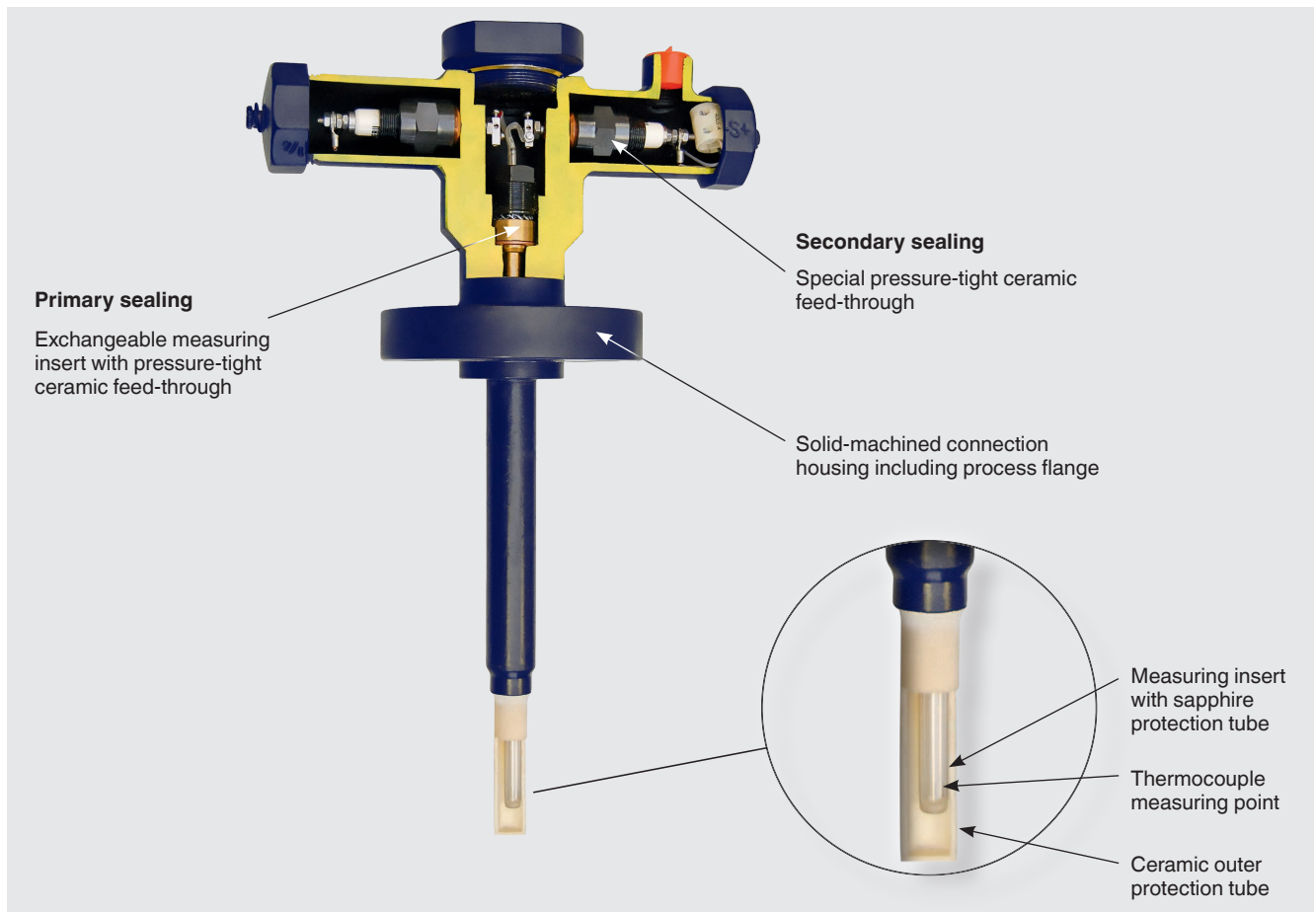

## Dimensions in mm

Dimensions	
Metal support tube	Ø 24 mm
Ceramic protection tube	Ø 15 mm
Measuring insert with protection tube	
Sapphire or ceramic	Ø 8 mm
Support tube length SL	Min. 148 mm [5.8"] Max. 953 mm [37.5"]
Insertion length U	Min. 395 mm [15.6"] Max. 1,200 mm [47.2"]

Other dimensions on request

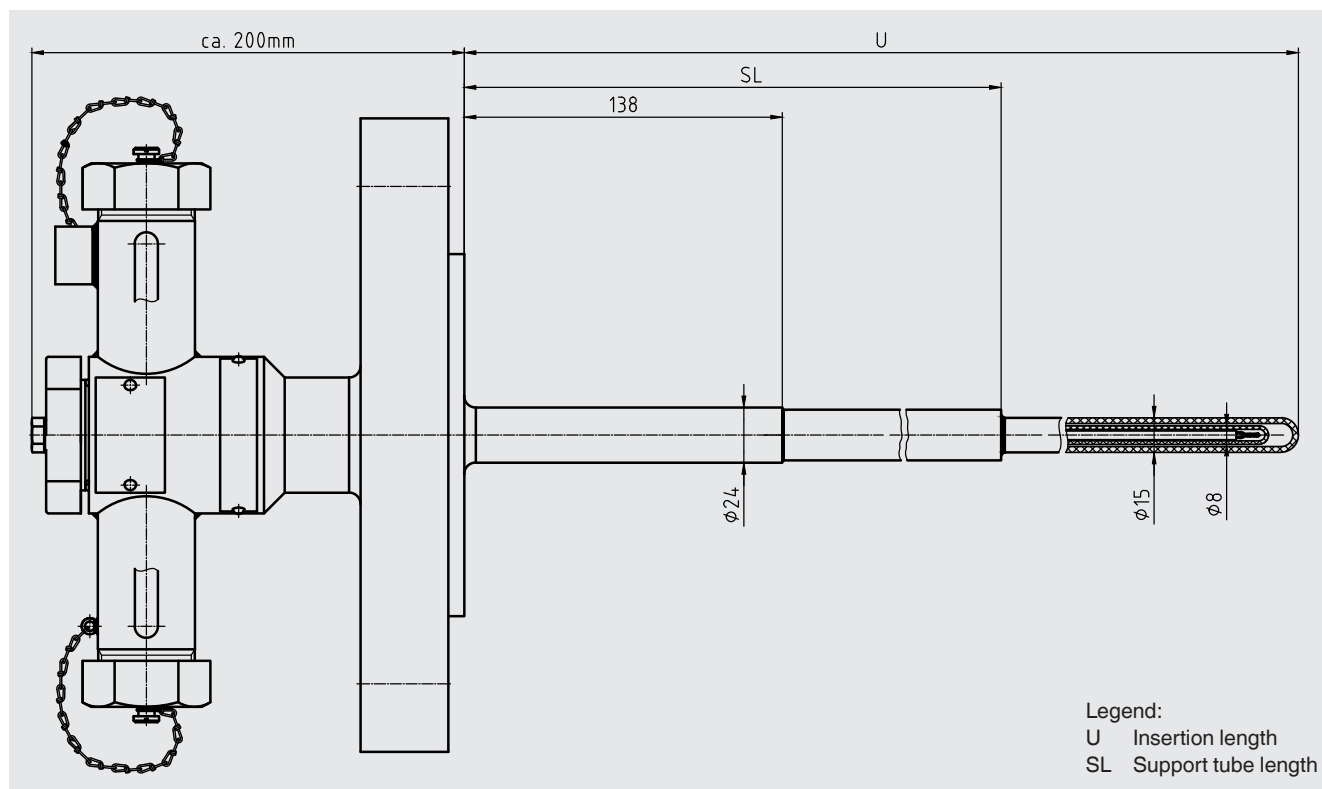

## Repair options

The construction of the thermocouple is designed so that a defect in an element following the removal from the reactor can be repaired and reconditioned economically in comparison to the cost of a new thermocouple.

For this, the complete defective element must be sent back to the manufacturer. Here, the metal connection housing with flange will be cleaned, surface coating renewed, and also all sealing faces freshly smoothed. Then, the connection housing will be completed with a new protection tube measuring insert and a combined pressure testing undertaken.

### Note:

It is not possible to deliver individual measuring inserts that will be fitted into the element case at the customer site since the combined pressure testing by the supplier is a constituent element of the guarantees.

## Ordering information

Model / Temperature range / Sensor / Measuring point / Connection housing / Thread size, cable entry / Protection tube / Flange nominal size / Pressure rating / Sealing face / Flange, support tube material / Support tube length SL / Insertion length U / Outer protection tube ceramic / Measuring insert / Options

© 08/2017 WIKA Alexander Wiegand SE & Co. KG, all rights reserved.  
The specifications given in this document represent the state of engineering at the time of publishing.  
We reserve the right to make modifications to the specifications and materials.

