

Threaded resistance thermometer With perforated protection tube model TW35 Model TR10-J

WIKA data sheet TE 60.10



for further approvals
see page 2

Applications

- Ventilation ducts
- Air-conditioning systems
- Room temperature measurement under difficult conditions
- Building control systems
- Sanitary, heating and air-conditioning technology

Special features

- Sensor ranges from -196 ... +600 °C [-320 ... +1,112 °F]
- With integrated perforated protection tube model TW35
- Explosion-protected versions are available for many approval types (see page 2)



Model TR10-J with perforated protection tube
model TW35

Description

Resistance thermometers of this series are designed for screw-fitting directly in ventilation ducts.

Due to the perforation, the measuring insert is in direct contact with the medium. This considerably improves the response time. The measuring insert is sealed towards the connection head so that no medium can escape outside.

Insertion length, process connection, protection tube design, connection head, type and number of sensors, accuracy and connection method can each be selected to suit the respective application.

A large number of different explosion-protected approvals are available for the TR10-J.









Optionally we can fit analogue or digital transmitters from the WIKA range into the connection head of the TR10-J.





Explosion protection (option)

The permissible power, P_{max} , as well as the permissible ambient temperature, for the respective category can be seen on the certificate for hazardous areas or in the operating instructions.

Transmitters have own certificates for hazardous areas. The permissible ambient temperature ranges of the built-in transmitters can be taken from the corresponding transmitter operating instructions and approvals.

Approvals (explosion protection, further approvals)

Logo	Description	Country
	EU declaration of conformity <ul style="list-style-type: none"> ■ EMC directive ¹⁾ EN 61326 emission (group 1, class B) and immunity (industrial application) ■ RoHS directive ■ ATEX directive (option) Hazardous areas - Ex i Zone 0 gas II 1G Ex ia IIC T1 ... T6 Ga Zone 1 gas II 2G Ex ia IIC T1 ... T6 Gb 	European Union
		
	IECEx (option) (in conjunction with ATEX) Hazardous areas - Ex i Zone 0 gas Ex ia IIC T1 ... T6 Ga Zone 1 gas Ex ia IIC T1 ... T6 Gb	International
	EAC (option) Hazardous areas - Ex i Zone 0 gas 0Ex ia IIC T3/T4/T5/T6 Zone 1 gas 1Ex ib IIC T3/T4/T5/T6 - Ex n Zone 2 gas 2Ex nA IIC T6...T1 Gc X	Eurasian Economic Community
	Ex Ukraine (option) Hazardous areas - Ex i Zone 0 gas II 1G Ex ia IIC T1...T6 Ga Zone 1 gas II 2G Ex ia IIC T1...T6 Gb	Ukraine
	INMETRO (option) Hazardous areas - Ex i Zone 0 gas Ex ia IIC T3 ... T6 Ga Zone 1 gas Ex ib IIC T3 ... T6 Gb	Brazil
	CCC (option) ²⁾ Hazardous areas - Ex i Zone 0 gas Ex ia IIC T1~T6 Ga Zone 1 gas Ex ia IIC T1~T6 Gb Zone 2 gas Ex ic IIC T1~T6 Gc	China
	KCs - KOSHA (option) Hazardous areas - Ex i Zone 0 gas Ex ia IIC T4 ... T6 Zone 1 gas Ex ib IIC T4 ... T6	South Korea
-	PESO (option) Hazardous areas - Ex i Zone 0 gas Ex ia IIC T1 ... T6 Ga Zone 1 gas Ex ib IIC T3 ... T6 Gb	India
	GOST (option) Metrology, measurement technology	Russia

Logo	Description	Country
	KazInMetr (option) Metrology, measurement technology	Kazakhstan
-	MTSCHS (option) Permission for commissioning	Kazakhstan
	BelGIM (option) Metrology, measurement technology	Belarus
	UkrSEPRO (option) Metrology, measurement technology	Ukraine
	Uzstandard (option) Metrology, measurement technology	Uzbekistan

- 1) Only for built-in transmitter
2) Without transmitter

Manufacturer's information and certificates

Logo	Description
	SIL 2 Functional safety (only in conjunction with model T32 temperature transmitter)

Instruments marked with "ia" may also be used in areas only requiring instruments marked with "ib" or "ic".
If an instrument with "ia" marking has been used in an area with requirements in accordance with "ib" or "ic", it can no longer be operated in areas with requirements in accordance with "ia" afterwards.

Approvals and certificates, see website

Sensor

Measuring element

Pt100, Pt1000 ¹⁾ (measuring current: 0.1 ... 1.0 mA) ²⁾

Connection method	
Single elements	1 x 2-wire 1 x 3-wire 1 x 4-wire
Dual elements	2 x 2-wire 2 x 3-wire 2 x 4-wire ³⁾

Validity limits of class accuracy per EN 60751		
Class	Sensor construction	
	Wire-wound	Thin-film
Class B	-196 ... +600 °C	-50 ... +500 °C
	-196 ... +450 °C	-50 ... +250 °C
Class A ⁴⁾	-100 ... +450 °C	-30 ... +300 °C
Class AA ⁴⁾	-50 ... +250 °C	0 ... 150 °C

- 1) Pt1000 only available as a thin-film measuring resistor
- 2) For detailed specifications for Pt100 sensors, see Technical information IN 00.17 at www.wika.com.
- 3) Not with 3 mm diameter
- 4) Not with 2-wire connection method

The table shows the temperature ranges listed in the respective standards, in which the tolerance values (class accuracies) are valid.

Electrical connection (colour code per IEC/EN 60751)

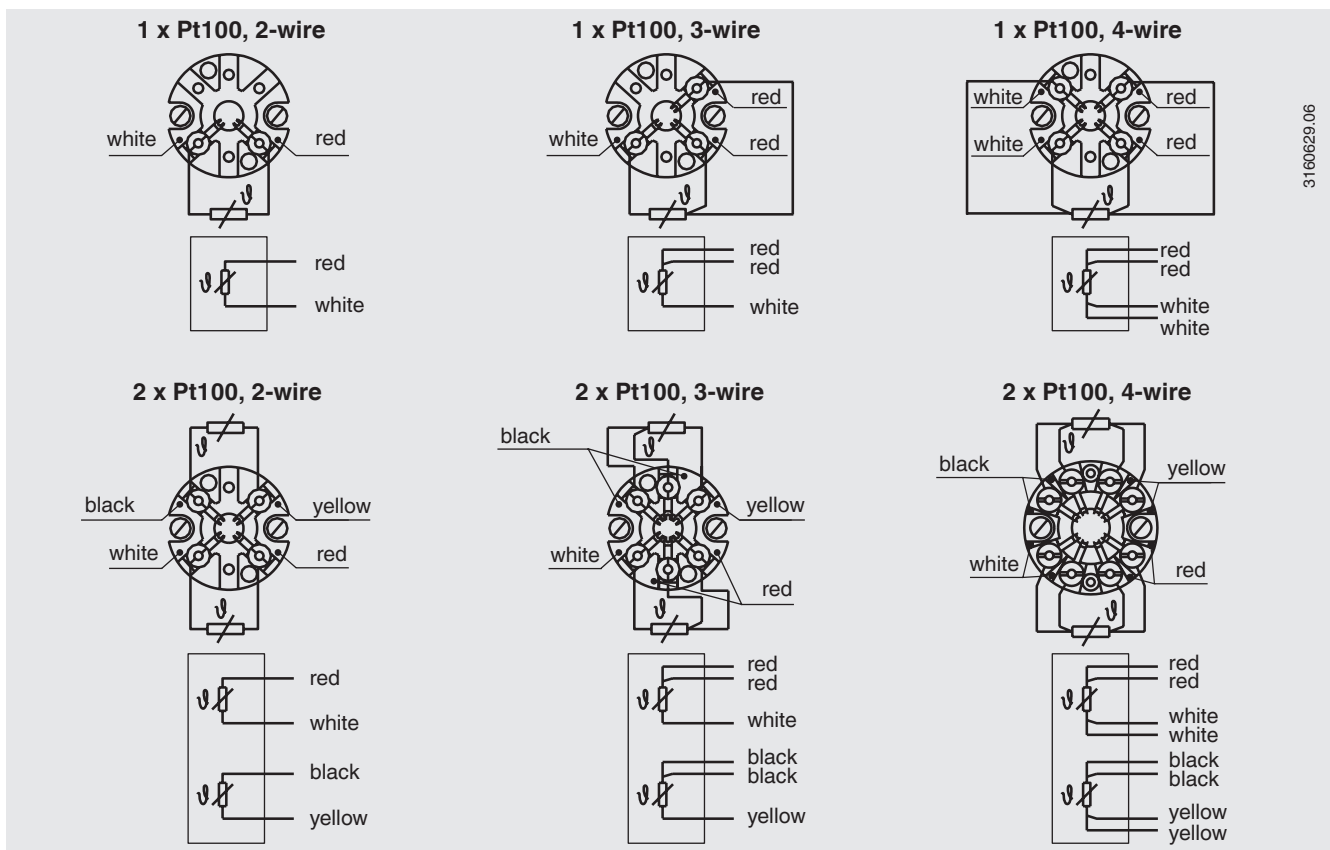

For the electrical connections of built-in temperature transmitters see the corresponding data sheets or operating instructions.

Connection head

■ European designs per EN 50446 / DIN 43735

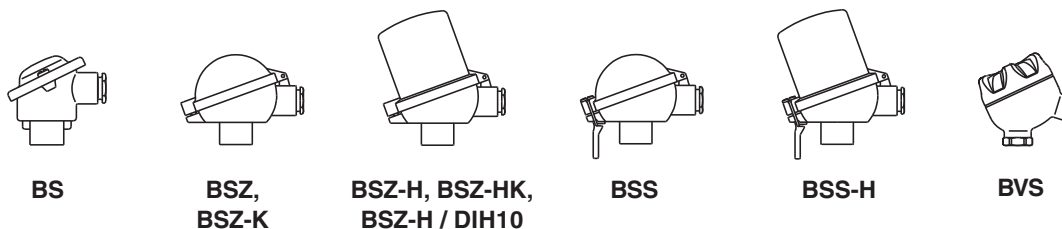

Model	Material	Cable entry thread size	Ingress protection (max.) ¹⁾ IEC/EN 60529	Cap	Surface	Connection to neck tube
BS	Aluminium	M20 x 1.5 or ½ NPT ³⁾	IP65 ⁴⁾	Flat cap with 2 screws	Blue, lacquered ⁵⁾	M24 x 1.5, ½ NPT
BSZ	Aluminium	M20 x 1.5 or ½ NPT ³⁾	IP65 ⁴⁾	Spherical hinged cover with cylinder head screw	Blue, lacquered ⁵⁾	M24 x 1.5, ½ NPT
BSZ-H	Aluminium	M20 x 1.5 or ½ NPT ³⁾	IP65 ⁴⁾	Raised hinged cover with cylinder head screw	Blue, lacquered ⁵⁾	M24 x 1.5, ½ NPT
BSZ-H (2x cable outlet)	Aluminium	2 x M20 x 1.5 or 2 x ½ NPT ³⁾	IP65 ⁴⁾	Raised hinged cover with cylinder head screw	Blue, lacquered ⁵⁾	M24 x 1.5
BSZ-H / DIH10²⁾	Aluminium	M20 x 1.5 or ½ NPT ³⁾	IP65	Raised hinged cover with cylinder head screw	Blue, lacquered ⁵⁾	M24 x 1.5, ½ NPT
BSS	Aluminium	M20 x 1.5 or ½ NPT ³⁾	IP65	Spherical hinged cover with clamping lever	Blue, lacquered ⁵⁾	M24 x 1.5, ½ NPT
BSS-H	Aluminium	M20 x 1.5 or ½ NPT ³⁾	IP65	Raised hinged cover with clamping lever	Blue, lacquered ⁵⁾	M24 x 1.5, ½ NPT
BVS	Stainless steel	M20 x 1.5 ³⁾	IP65	Precision-cast screw-on lid	Blank, electropolished	M24 x 1.5
BSZ-K	Plastic	M20 x 1.5 or ½ NPT ³⁾	IP65	Spherical hinged cover with cylinder head screw	Black	M24 x 1.5
BSZ-HK	Plastic	M20 x 1.5 or ½ NPT ³⁾	IP65	Raised hinged cover with cylinder head screw	Black	M24 x 1.5

Model	Explosion protection		
	Without	Ex i (gas) Zone 0, 1, 2	Ex i (dust) Zone 20, 21, 22
BS	x	x	-
BSZ	x	x	x
BSZ-H	x	x	x
BSZ-H (2 x cable outlet)	x	x	x
BSZ-H / DIH10²⁾	x	x	-
BSS	x	x	-
BSS-H	x	x	-
BVS	x	x	-
BSZ-K	x	x	-
BSZ-HK	x	x	-

1) IP ingress protection of the connection head. The IP ingress protections of the complete instrument TR10-J must not inevitably correspond to the connection head.

The indicated ingress protection does not apply for the perforated probe tip.

It is valid for the connection head with corresponding cable gland in case of a correctly installed thermometer.

2) LED display DIH10

3) Standard (others on request)

4) Ingress protections, which describe temporary or lasting submersion, available on request

5) RAL 5022

■ North American designs



KN4-A
KN4-P

Model	Material	Cable entry thread size	Ingress protection (max.) ¹⁾ IEC/EN 60529	Cover / Cap	Surface	Connection to neck tube
KN4-A	Aluminium	½ NPT or M20 x 1.5 ²⁾	IP65	Screw-on lid	Blue, lacquered ³⁾	M24 x 1.5, ½ NPT
KN4-P ⁴⁾	Polypropylene	½ NPT	IP65	Screw-on lid	White	½ NPT

Model	Explosion protection		
	Without	Ex i (gas) Zone 0, 1, 2	Ex i (dust) Zone 20, 21, 22
KN4-A	x	x	-
KN4-P ⁴⁾	x	-	-

1) IP ingress protection of the connection head. The IP ingress protections of the complete instrument TR10-J must not inevitably correspond to the connection head.

2) Standard (others on request)

3) RAL 5022

4) On request

Connection head with digital display



Connection head BSZ-H with LED display model DIH10
see data sheet AC 80.11

To operate the digital displays, a transmitter with a 4 ... 20 mA output is always required.

Cable entry

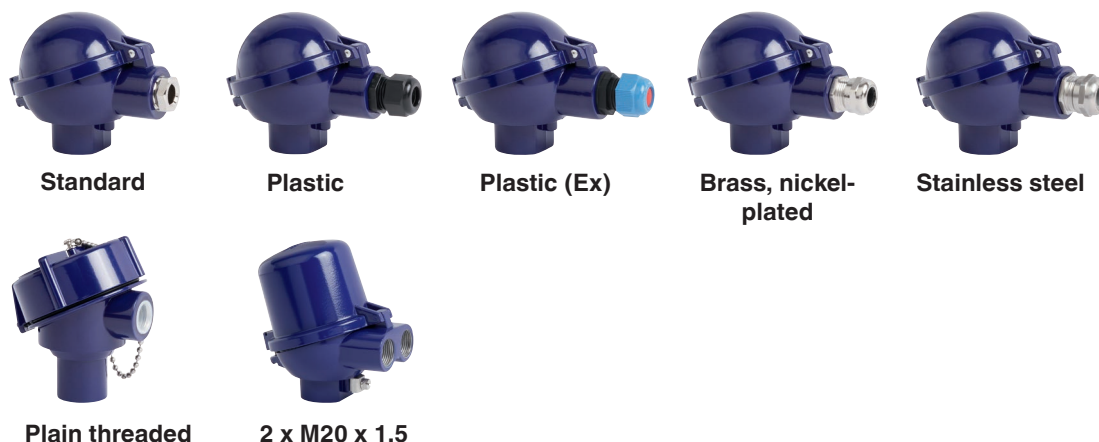

The figures show examples of connection heads.

Cable entry	Cable entry thread size	Min./max. ambient temperature
Standard cable entry ¹⁾	M20 x 1.5 or ½ NPT	-40 ... +80 °C
Plastic cable gland (cable Ø 6 ... 10 mm) ¹⁾	M20 x 1.5 or ½ NPT	-40 ... +80 °C
Plastic cable gland (cable Ø 6 ... 10 mm), Ex e ¹⁾	M20 x 1.5 or ½ NPT	-20 ... +80 °C (standard) -40 ... +70 °C (option)
Nickel-plated brass cable gland (cable Ø 6 ... 12 mm)	M20 x 1.5 or ½ NPT	-60 ³⁾ / -40 ... +80 °C
Stainless steel cable gland (cable Ø 7 ... 12 mm)	M20 x 1.5 or ½ NPT	-60 ³⁾ / -40 ... +80 °C
Plain threaded	M20 x 1.5 or ½ NPT	-
2 x M20 x 1.5 ²⁾	2 x M20 x 1.5	-

Cable entry	Colour	Ingress protection (max.) ⁴⁾ IEC/EN 60529	Explosion protection		
			without	Ex i (gas) Zone 0, 1, 2	Ex i (dust) Zone 20, 21, 22
Standard cable entry ¹⁾	Blank	IP65	x	x	-
Plastic cable gland ¹⁾	Black or grey	IP66 ⁵⁾	x	-	-
Plastic cable gland, Ex e ¹⁾	Light blue	IP66 ⁵⁾	x	x	x
Plastic cable gland, Ex e ¹⁾	Black	IP66 ⁵⁾	x	-	-
Brass cable gland, nickel-plated	Blank	IP66 ⁵⁾	x	-	-
Brass cable gland, nickel-plated, Ex e	Blank	IP66 ⁵⁾	x	x	x
Stainless steel cable gland	Blank	IP66 ⁵⁾	x	x	x
Stainless steel cable gland, Ex e	Blank	IP66 ⁵⁾	x	x	x
Plain threaded	-	IP00	x	x	x ⁶⁾
2 x M20 x 1.5 ²⁾	-	IP00	x	x	x ⁶⁾

1) Not available for BVS connection head

2) Only for BSZ-H connection head

3) Special version on request (only available with selected approvals), other temperatures on request

4) IP ingress protection of the connection head. The IP ingress protections of the complete instrument TR10-J must not inevitably correspond to the connection head.

5) Ingress protections, which describe temporary or lasting submersion, available on request

6) Suitable cable gland required for operation

Ingress protection per IEC/EN 60529

Degrees of protection against solid foreign bodies (defined by the first index number)

First index number	Degree of protection / short description	Test parameter
5	Dust-protected	per IEC/EN 60529
6	Dust-tight	per IEC/EN 60529

Degrees of protection against water (defined by the second index number)

Second index number	Degree of protection / short description	Test parameter
4	Protected against splash water	per IEC/EN 60529
5	Protected against water jets	per IEC/EN 60529
6	Protected against strong water jets	per IEC/EN 60529
7 ¹⁾	Protected against the effects of temporary immersion in water	per IEC/EN 60529
8 ¹⁾	Protected against the effects of continuous immersion in water	by agreement

1) Ingress protections, describing temporary or permanent immersion, on request

Standard ingress protection of model TR10-J is IP65.

The stated degrees of protection apply under the following conditions:

- Use of a suitable cable gland
- Use of a cable cross-section appropriate for the gland or select the appropriate cable gland for the available cable
- Adhere to the tightening torques for all threaded connections

Transmitter

Mounting onto the measuring insert

With mounting on the measuring insert, the transmitter replaces the terminal block and is fixed directly to the terminal plate of the measuring insert.

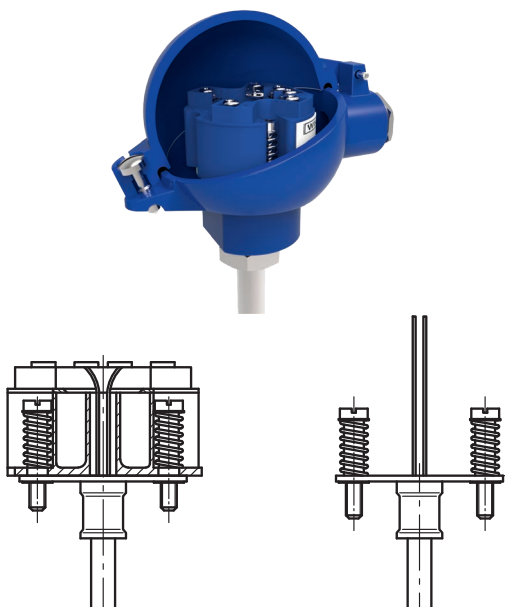
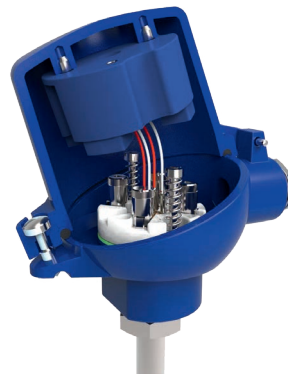

Fig. left: Measuring insert with mounted transmitter (here: model T32)
Fig. right: Measuring insert prepared for transmitter mounting

Mounted within the cap of the connection head

Mounting the transmitter in the cap of the connection head is preferable to mounting it on the measuring insert. With this type of mounting, for one, a better thermal insulation is ensured, and in addition, exchange and mounting for servicing is simplified.



Transmitter models

HART
COMMUNICATION PROTOCOL



Output signal 4 ... 20 mA, HART® protocol		
Transmitter (selectable versions)	Model T15	Model T32
Data sheet	TE 15.01	TE 32.04
Output		
4 ... 20 mA	x	x
HART® protocol	-	x
Connection method		
1 x 2-wire, 3-wire or 4-wire	x	x
Measuring current	< 0.2 mA	< 0.3 mA
Explosion protection	Optional	Optional

Possible mounting positions for transmitters

Connection head	T15	T32
BS	○	-
BSZ, BSZ-K	○	○
BSZ-H, BSZ-HK	●	●
BSZ-H (2x cable outlet)	●	●
BSZ-H / DIH10	○	○
BSS	○	○
BSS-H	●	●
BVS	○	○
KN4-A / KN4-P	○	○

○ Mounted instead of terminal block

● Mounted within the cap of the connection head

– Mounting not possible

The mounting of a transmitter on the measuring insert is possible with all the connection heads listed here. The fitting of a transmitter in the (screw) cap of a North American design connection head is not possible.

Mounting of 2 transmitters on request.

For a correct determination of the overall measuring deviation, the sensor and transmitter measuring deviations must be added.

Functional safety (option) with temperature transmitter model T32



In safety-critical applications, the entire measuring chain must be taken into consideration in terms of the safety parameters. The SIL classification allows the assessment of the risk reduction achieved by the safety installations.

Selected TR10-J resistance thermometers, in combination with a suitable temperature transmitter (e.g. model T32.1S, TÜV certified SIL version for protection systems developed

in accordance with IEC 61508), are suitable as sensors for safety functions to SIL 2.

For detailed specifications, see Technical information IN 00.19 at www.wika.com.

Components model TR10-J

Fig. with parallel thread, for tapered thread see "Process connection"

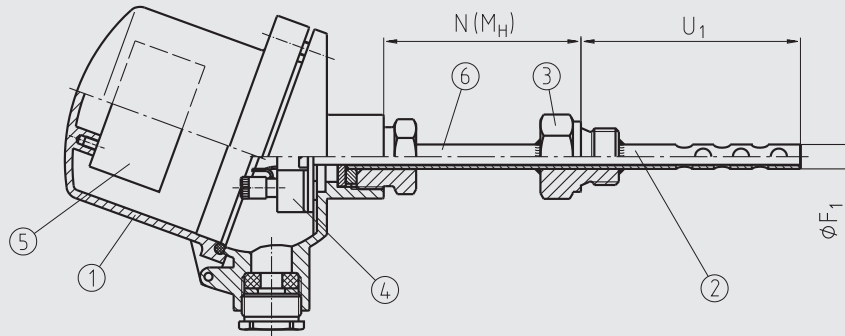

Legend:

- ① Connection head
- ② Protection tube model TW35
- ③ Process connection
- ④ Measuring insert
- ⑤ Transmitter (option)
- ⑥ Neck tube

U₁ Insertion length
 F₁ Protection tube diameter
 N (M_H) Neck length

3224716.01

Protection tube model TW35

Protection tube design

Protection tube straight, form 2G DIN 43772

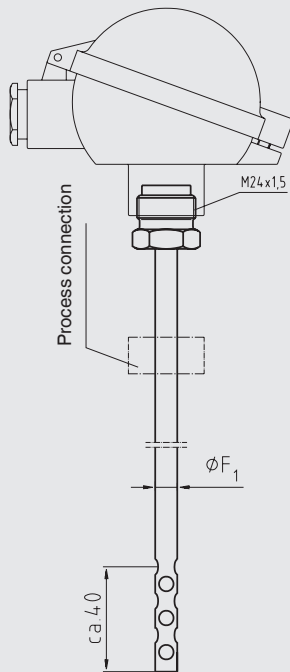

3164357.01

Protection tube versions

The protection tube is made of drawn tube with a welded bottom and is screwed into the connection head. The cable outlet can be aligned by redating the connection head. The process connection, in accordance with the customer specification, is welded onto the protection tube in the factory, which also fixes the insertion length. Insertion lengths to DIN standards are preferable.

Designs to DIN standards and also special designs (e.g., with tapered protection tube, reinforced neck tube, etc.) are available in 1.4571 stainless steel or special materials on request.

For further technical specifications on the protection tube please see WIKA data sheet TW 95.35.

Protection tube in accordance with DIN 43772	Insertion length	Process connection	Protection tube external diameter F ₁	Neck length N
Design 2G	160	G 1/2 B, mounting thread	8, 11, 12 or 14 mm	130
		G 1 B, mounting thread		
Design 2G	250	G 1/2 B, mounting thread	8, 11, 12 or 14 mm	130
		G 1 B, mounting thread		
Design 2G	400	G 1/2 B, mounting thread	8, 11, 12 or 14 mm	130
		G 1 B, mounting thread		

Above designs are also available with 1/2 NPT process connection. In this case, however, these will not conform to DIN 43772.

Process connection

Type of threaded connection

- Male thread, welded with protection tube
- Compression fitting, primarily with 12 mm diameter protection tubes
(Compression fittings allow simple adjustment to the required insertion length at the installation point.
After tightening, the compression fitting can no longer be moved along the protection tube.)
- Union nut

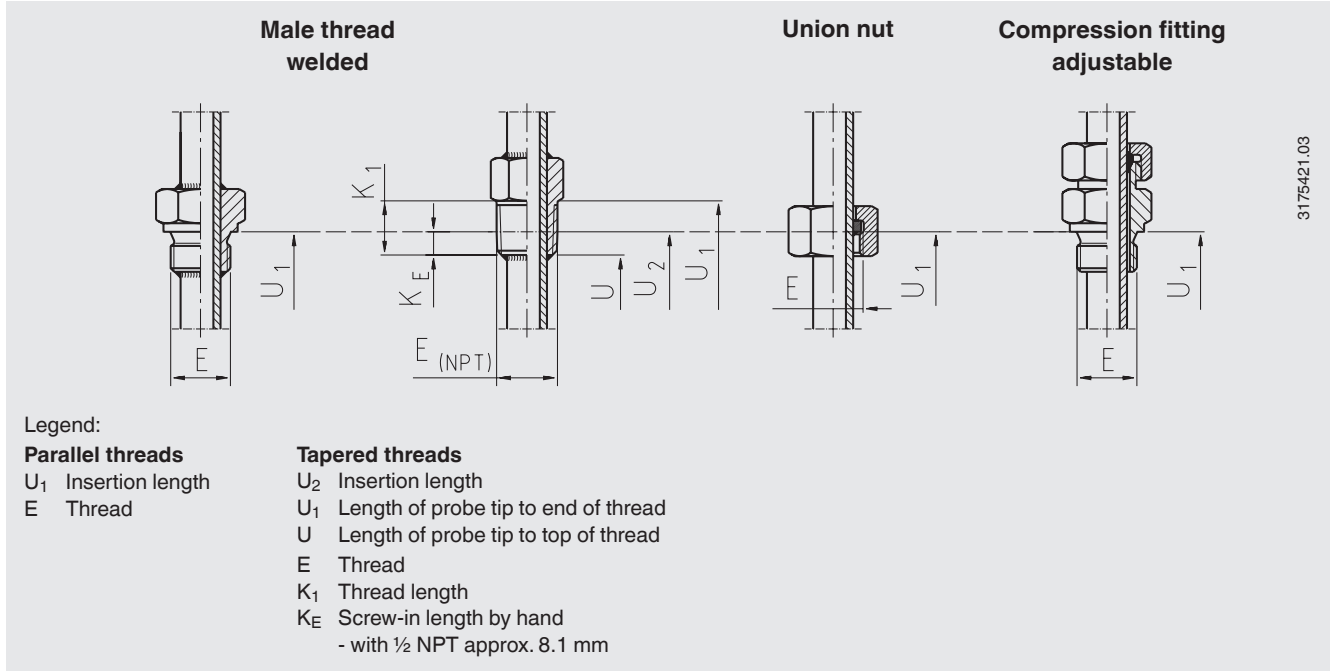

Connection type	Protection tube diameter			
	9 mm	11 mm	12 mm	14 mm
Male thread	G ½ B	G ½ B	G ½ B	G ½ B
	-	G 1 B	G 1 B	G 1 B
	½ NPT	½ NPT	½ NPT	½ NPT
	M20 x 1.5	M20 x 1.5	M20 x 1.5	M20 x 1.5
Compression fitting	-	-	G ½ B	-
	-	-	½ NPT	-
Union nut	G ½ B	G ½ B	G ½ B	G ½ B

Operating conditions

Ambient and storage temperature

-40 ... +80 °C

Other ambient and storage temperatures on request

Certificates (option)

Certification type	Measurement accuracy	Material certificate
2.2 test report	x	x
3.1 inspection certificate	x	x
DKD/DAkkS calibration certificate	x	-

The different certifications can be combined with each other.

For calibration, the measuring insert is removed from the thermometer. The minimum length (metal part of the probe) for carrying out a measurement accuracy test 3.1 or DKD/DAkkS is 100 mm.

Calibration of shorter lengths on request.

Ordering information

Model / Sensor / Explosion protection / Process connection / Thread size / Measuring element / Connection method / Temperature range / Probe diameter / Insertion length A / Neck length N(MH) / Certificates / Options

© 04/2008 WIKA Alexander Wiegand SE & Co. KG, all rights reserved.
The specifications given in this document represent the state of engineering at the time of publishing.
We reserve the right to make modifications to the specifications and materials.

