

Hazardous Area Explosion-proof Transmitters Model E-10, E-11

Datasheet E-10



Meets ANSI / ISA 12.27.01-2003
single seal requirements - no
dual seal required

Applications

- Wellhead monitoring
- Refining, chemical, petrochemical
- Offshore platforms, pipelines
- Natural gas compressors

Special Features

- FM-approved explosion-proof for Class I
Division 1 hazardous locations
- Available with 4 ... 20 mA, 2-wire or 1 ... 5 V,
3-wire low power output signals
- Engineered to withstand harsh environments
- NACE MR0175 compliant wetted parts
- Retrofits many existing oil and gas applications



Left: E-10 NPT pressure transmitter with cable
Right: E-11 flush diaphragm pressure transmitter
with optional flying leads

The E-10 and E-11 explosion-proof pressure transmitters are specifically designed to meet the durability and performance requirements of oil and gas pressure monitoring applications.

These pressure transmitters feature an industry standard 4-20 mA 2-wire or 1-5V 3-wire low power signal output and NEMA 4X (IP67) ingress protection. They are extremely resistant to pressure spikes, vibration and moisture intrusion. NACE MR-01-75 compliant wetted parts provides extra resistance against sulfide stress cracking when exposed to media containing sulphur. Both are available with a factory sealed epoxy flying lead assembly for easier installation.

The E-10 features an NPT process connection with an all-welded stainless steel measuring cell for media compatibility.

There are no internal soft sealing materials that may react with the media or deteriorate over time.

The E-11 features a flush diaphragm process connection. This flat sensing surface is specifically designed for the measurement of viscous fluids or media containing solids that may clog the NPT process connection.

The transmitters are engineered to meet Class I, Division 1 explosion-proof protection for installation in hazardous environments. Each transmitter undergoes extensive quality control testing and calibration to achieve a linearity of $\leq 0.25\%$ full scale. In addition, each pressure transmitter is temperature compensated to assure accuracy and long-term stability even when exposed to severe ambient temperature variations.

Specifications

Type E-10 / E-11

Pressure range	5 psi	10 psi	15 psi	25 psi	30 psi	60 psi	100 psi	200 psi	300 psi
Maximum pressure*	29 psi	58 psi	72 psi	145 psi	145 psi	240 psi	500 psi	1,160 psi	1,160 psi
Burst pressure**	35 psi	69 psi	87 psi	170 psi	170 psi	290 psi	600 psi	1,390 psi	1,390 psi
Pressure range	500 psi	1,000 psi	1,500 psi	2,000 psi	3,000 psi	5,000 psi	8,000 psi ¹	10,000 psi ¹	15,000 psi ¹
Maximum pressure*	1,160 psi	1,740 psi	2,900 psi	4,600 psi	7,200 psi	11,600 psi	17,400 psi	17,400 psi	21,750 psi
Burst pressure**	5,800 psi	7,970 psi	11,600 psi	14,500 psi	17,400psi	24,650 psi ²	34,800 psi	34,800 psi	43,500 psi
{Vacuum, gauge pressure, compound ranges and absolute pressure ranges are available}									
Materials									
■ Wetted parts			Nace compliant ⁴						
➢ Model E-10			Stainless steel (≥ 300 psi stainless steel and Elgiloy)						
➢ Model E-11			Stainless steel						
■ Case			O-ring: NBR {Viton®}						
■ Case			Stainless steel						
Internal transmission fluid			Synthetic oil (only for pressure ranges up to 300 psi or flush diaphragm units)						
Power supply U _B		DC V	10 < U _B < 30 for 4 ... 20 mA, 2-wire 6 < U _B < 30 for 1 ... 5 V, 3 wire low power version						
Signal output and maximum load R _A			4 ... 20 mA, 2-wire R _A ≤ (U _B - 10 V) / 0.02 A with R _A in Ohm and U _B in Volt 1 ... 5 V, 3-wire R _A > 10 kOhm						
Response time (10 ... 90 %)		ms	≤ 1 (≤ 10 ms when media temperatures are below -22 ° F (-30 ° C) for pressure ranges up to 300 psi or with flush diaphragm)						
Accuracy ³⁾		% of span	≤ 0.25 (BFSL)						
		% of span	≤ 0.5 (limit point calibration)						
Hysteresis		% of span	≤ 0.1						
Non-repeatability		% of span	≤ 0.1						
1-year stability		% of span	≤ 0.2 (at reference conditions)						
Permissible temperature of									
■ Medium			-22 ... +212 °F	{-40 ... +221 °F}	-30 ... +100 °C	{-40 ... +105 °C}			
■ Ambient			-22 ... +212 °F	{-40 ... +221 °F}	-30 ... +100 °C	{-40 ... +105 °C}			
■ Storage			-40 ... +221 °F	{-58 ... +221 °F}	-40 ... +105 °C	{-50 ... +105 °C}			
Compensated temp. range			32 ... +176 °F			0 ... +80 °C			
Temperature coefficients in compensated temp range									
■ Mean TC of zero			% of span	≤ 0.2 / 10 K (< 0.4 for pressure range < 100 InWC)					
■ Mean TC of range			% of span	≤ 0.2 / 10 K					
EMI specifications			89/336/EWG interference emission and immunity see EN 61 326						
Approval authority			<ul style="list-style-type: none"> ■ Factory mutual (FM / CSA) explosion-proof for: Class I, Division 1, Groups A, B, C and D ■ Dust ignition-proof for: Class II / III, Division 1, Groups E, F and G FM Standards according to class number 3600, 3615 and 3810						
HF-immunity		V/m	10						
Burst		KV	4						
Shock resistance		g	1,000 according to IEC 60068-2-27 (mechanical shock)						
Vibration resistance		g	20 according to IEC 60068-2-6 (vibration under resonance)						
Wiring protection			Protected against reverse polarity, over voltage and short circuiting						
Ingress protection			NEMA 4X / IP 67						
Weight		lb	Approximately 0.4						

* Pressure applied up to the maximum rating will cause no permanent change in specifications but may lead to zero and span shifts

**Exceeding the burst pressure may result in destruction of the transmitter

- 1) Only Type E-10.
 - 2) For Type E-11: the burst pressure is limited to 21,000 psi unless the pressure seal is accomplished by using the sealing ring underneath the hex.
 - 3) Includes non-linearity, hysteresis and repeatability. Limit point calibration performed in vertical mounting position with pressure connection facing down.
 - 4) Wetted parts comply with recommendations per NACE MR0175. Environmental limits apply to certain materials. Consult latest standard for details.
- { } Items in curved brackets are options available at additional cost.

Dimensions in inches (mm)

1/2 male conduit with 6 foot (1.8 m) cable and free ends
NEMA 4X (IP 67)
Order code: 2X

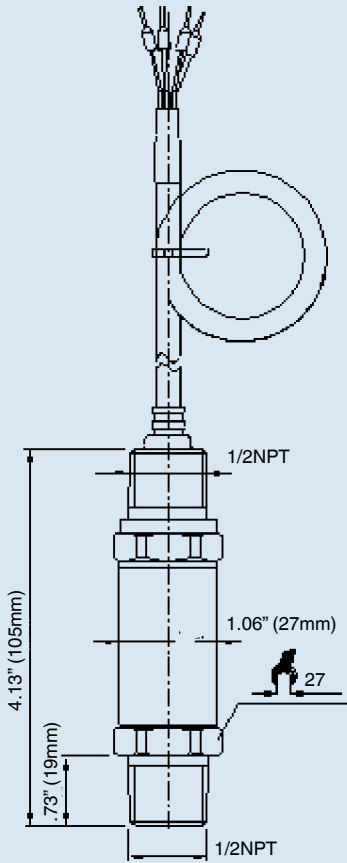

1/2 male conduit with 6 foot (1.8 m) flying leads NEMA 4X (IP 67)
Order code: 3X

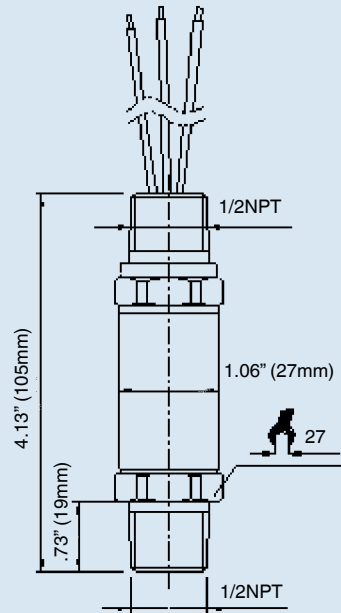

Pressure connections

1/4 NPT male
Order code: NB

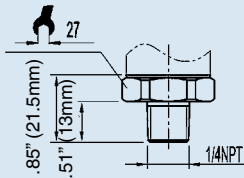

1/2 NPT male
Order code: ND

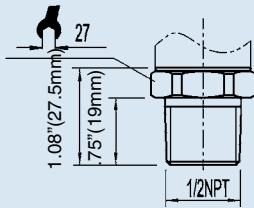

G 1/2 male
EN 837
Order code: GD

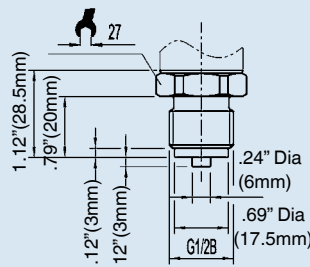

G 1/4 male
EN 837
Order code: GB

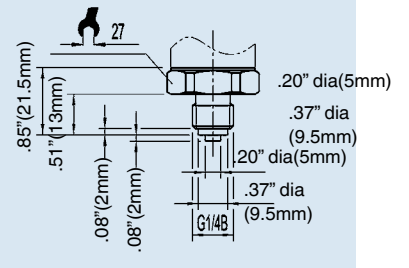

E-11 flush diaphragm pressure connections

E-11 G 1
50 InWC to 25 psi
Order code: 85

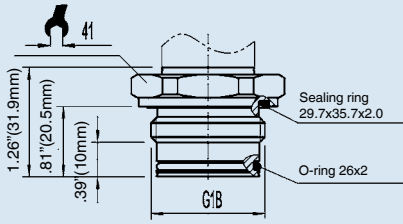

E-11 G 1/2
30 psi to 8,000 psi
Order code: 86

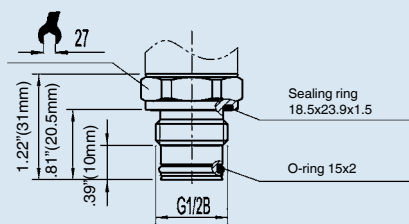

Matching P-1 weld insert adapters for E-11 flush diaphragm transmitters

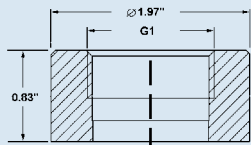

P-1 G1 weld insert adapter
Part # 1206974
for pressure ranges ≤ 25 psi

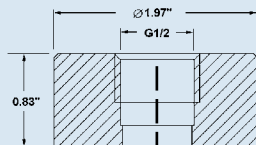

P-1 G1/2 weld insert adapter
Part # 1097008
for pressure ranges ≥ 30 psi

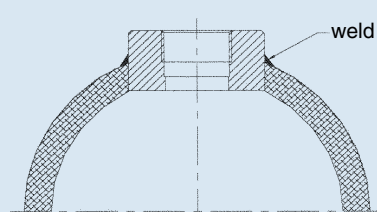

Cross section view of P-1 adapter installed in pipe.

Wiring

6 foot (1.82m)
cable or flying leads

2-wire system

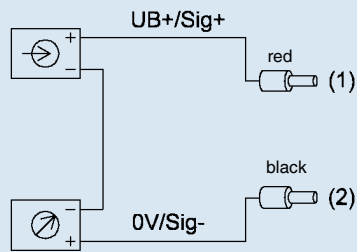

shield - ground

3-wire system

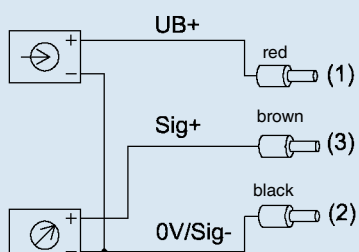

Green - ground

Legend:

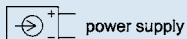

power supply



load (e.g. display)

Sig+ output signal positive
UB+ power supply positive
0V power supply negative
Sig- output signal negative

